

Fig. 1

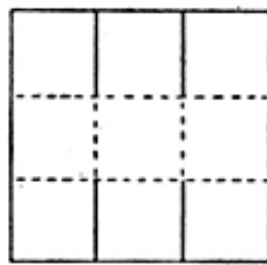

Fig. 2

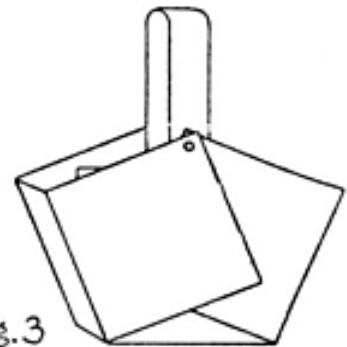

Fig. 3

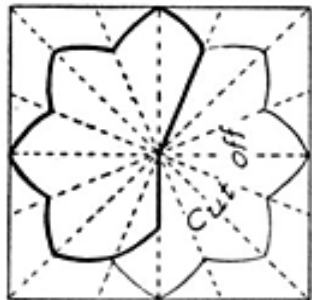
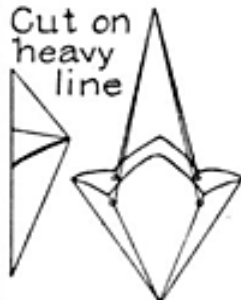

Fig. 1



Cut on heavy line

Fig. 2



Fig. 3

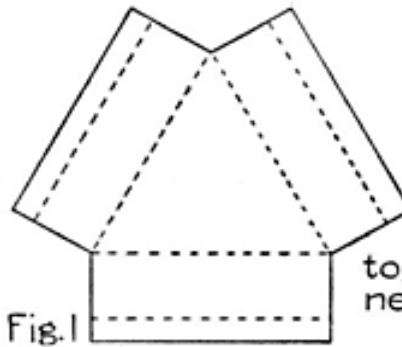

Fig. 1

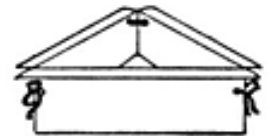

Fig. 2

Fold on dotted lines and tie together at corners with ribbon

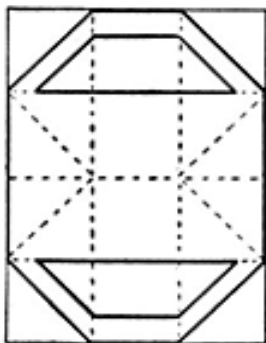

Fig. 1

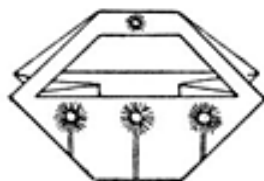

Fig. 2



Fig. 1

To make this May basket cut two flat pieces of heavy paper and sew together. It may be decorated



Fig. 2

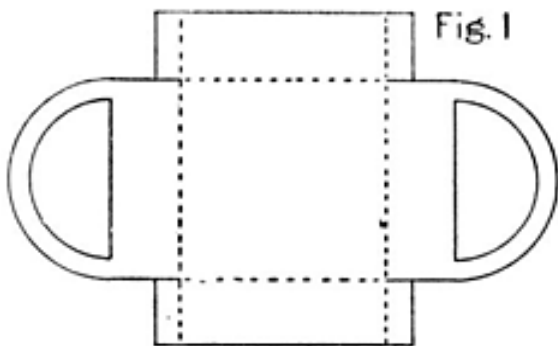

Fig. 1

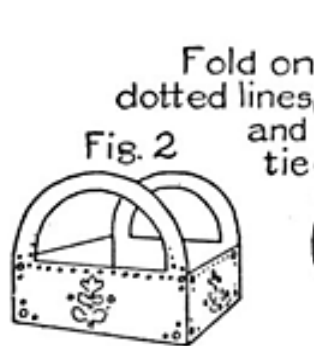
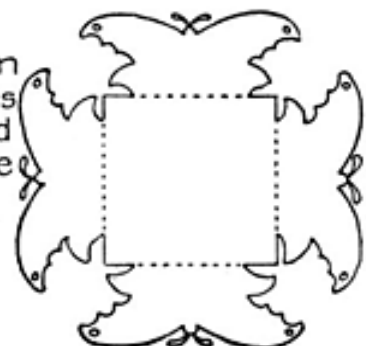

Fig. 2

Fold on dotted lines and tie



FOR MAY DAY